

C10 CONTROLLER

Instruction Manual

Model C10-1VFEF
C10-3VFEF
C10-5VFEF

This instruction manual applies to C10-controller which installs the program version 6 and later.
Please check the program version of your C10-controller on the version information.

The controller which is installed the program version 5 and later corresponds to the RoHS Directive and confirms with the CE Marking.

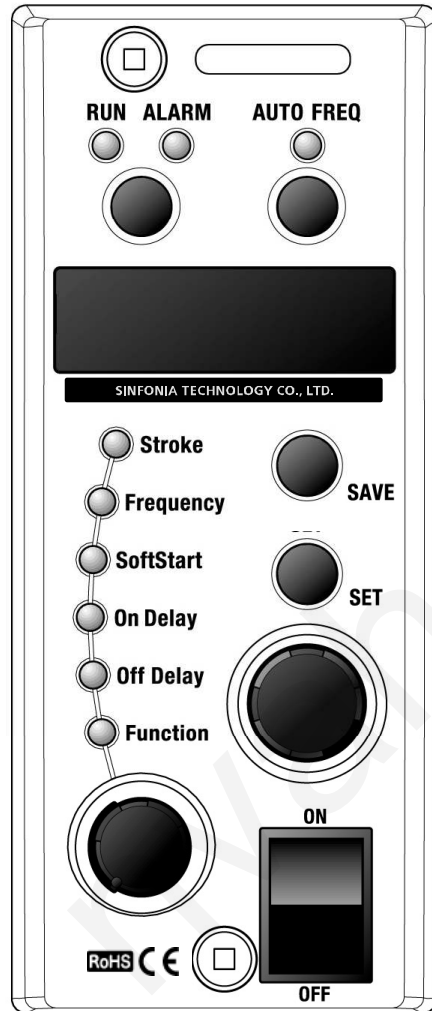

HTE302172

Before use C10-controller, please read this "Instruction Manual" including "Safety Instructions" thoroughly to use it in the right way. Please keep it on file for further reference.

SINFONIA TECHNOLOGY CO., LTD.

Introduction

Thank you for buying your C10-Series controller. Before use C10-controller, please read this "Instruction Manual", including "Safety Instructions", thoroughly to use C10-controller safely and in the right way. Please keep it on file for further reference and/or maintenance. Please hand this manual to the operator of the partsfeeder.

Contents

Introduction.....	1
Safety Instructions	2
Wiring Connections	5
How to operate the Control Panel	7
· Name and Function of the Buttons, Lamps and Dials on the Control Panel	7
· How to Run and Stop the Partsfeeder	8
· Alarm by blinking "RUN" lamp	8
· Basic Setting up Procedure	9
· How to adjust the Function Set Value	11
Initial Setting	13
· Preparation for operation	13
· How to adjust the Drive Frequency Output Range	14
· How to adjust the Stroke on the Auto-tuning Mode	16
· How to set the Stroke on the Constant Voltage Mode	18
· How to adjust the Stroke on the Constant Stroke Mode	20
· Scaling of the stroke	22
Additional Function.....	24
· Setting up for Key Lock function	24
· Setting On and Off Delay Time	24
· Setting of Soft Start Ramp-up Time	24
· Connection of Overflow and Stroke sensors	25
How to use External Signal Terminals	29
· External Operation Signal Terminals "P1" and "P2"	29
· Operation Synchronous Signal Terminals "Q1" and "Q2" and "AUX .OUT"	30
· Speed Change /Control by 4-20mA Current /Two-Rate-of-Feed control by External Rheostats	30
Conformity with CE Marking	36
Trouble shooting	39
Function Table	40
How to Initialize the Settings	41
Outline Dimensions.....	42
Accessory List	43
Specifications	44
Guarantee	45
Sales offices	46





Safety Instructions

- Please read this article thoroughly without fail -

Before use C10-controller, please read this "Safety Instructions" carefully to use C10-controller in the right way.

Use of this C10-controller involves electrical current. There is potential hazard of electric shock to the operator. Failure to follow these instructions may result serious personal injury or property damage.

Safety Instructions are classified into "Danger", "Warning", "Caution" and "Request".

 Danger	This label shows an immediate danger. Misuse of C10-controller and/or risky action of any person should cause the person serious and/or fatal injury and/or severe damage to your property.
 Warning	This label shows an indirect danger. Misuse of the partsfeeder and/or risky action of any person should cause the person injury and/or damage to your property.
 Caution	This label shows an indirect danger. Misuse of C10-controller and/or risky action of any person might cause the person injury and/or damage to your property.
 Request	This label shows the manufacturer's strong recommendation to use the partsfeeder properly. Misuse of C10-controller and/or risky action of any person may not cause the person injury and/or damage of your property.

■ Please keep this "Instruction Manual" on file for further reference giving easy access to the operator.

■ The partsfeeder that is sold or rented to the other must keep this "Instruction Manual" on it highly visible.

They must use the partsfeeder in the right way.

■ Not all danger should be covered by the "Instruction Manual". Please read the Instruction Manual and act on the principle of Safety First.

Safety Instructions

-Continued-

Danger

- Don't apply C10-controller to a piezo-electric type partsfeeder.
- Don't use C10-controller where inflammable material exists. It has not an explosion-proof structure.
- You should fix the controller firmly on the rigid structure. Otherwise the operator might be injured by falling down and/or abnormal operation of it.
- Don't sprinkle C10-controller with water and/or submerge it in water, or cause the operator injury and/or get an electric shock.
- Before performing any maintenance work, such as opening cover, wiring, replacing fuse and etc., the electrical supply must be disconnected at the safety disconnect switch. The electrical circuit inside involves high voltage and the operator should get an electric shock.

Warning

- The electrical power supply to C10-controller must be made through a customer-supplied safety disconnect switch mounted next to C10-controller.
- Operate C10-controller within the specified range in the contracted specifications, or it causes it malfunction, damage and/or shorter life time.
- Don't get on and/or put a thing on the controller, or it results injury by fall, and/or damage and/or malfunction of it.
- Don't bruise cords and/or leads. Bending by force, pulling, winding and/or clamping them cause fire and/or getting an electric shock by leakage and/or mal-conduction, and/or abnormal operation.
- Wire C10-controller correctly consulting the "Instruction Manual". Faulty wiring causes damage and/or abnormal operation of it.
- Before supply C10-controller electrical power, check the wiring.
- C10-controller must be grounded properly without fail. Don't operate it without grounding.

Caution

- Please reserve maintenance space around C10-controller and partsfeeder for daily check and maintenance.
- Don't install C10-controller dusty area. It has not dust tight structure.
- Please lift C10-controller with its body and/or mounting base. Don't lift it with a cable.
- The output frequency range must match that of the partsfeeder or linear feeder drive unit. Mismatch causes burnout of the coil of the drive.
- Don't supply C10-controller with electric power through a PWM type inverter, or it must break C10-controller.
- Don't run and stop C10-controller frequently. To run and stop it every few minutes and power supply through an electromagnetic contactor mounted on the power supply make inner electronic parts deteriorate severely. External operation signal enables it to run and stop frequently.
- Don't provide any switch gear on the output line between C10-controller and the drive unit to run and stop the drive, or C10-controller must be break. Don't arc weld on the bowl, chute and trough while C10-controller and the drive unit are wired, or earth leakage through C10-controller must break it.

Request

- When C10-controller might be used in circumstance and/or conditions that are out of the supposition of this "Instruction Manual", and/or use of it might threaten people's life and property in danger, consider people's safety and act on the principle of Safety First by the margin of the rating and performance.
- When C10-controller might be out of order or become useless, scrap it as an industrial waste subject to local regulation.
- C10-controller should be installed on a rigid frame in such location as vibration-free, no heat transfer, dry and no condensation, and not frozen.
- Before connect or disconnect a connector, the electrical power supply must be disconnected at the safety disconnect switch. Don't force a connector, or it causes getting an electric shock by leakage and/or mal-conduction, damage and/or abnormal operation.

Wiring Connections

Wire the controller and a partsfeeder or a linear feeder.

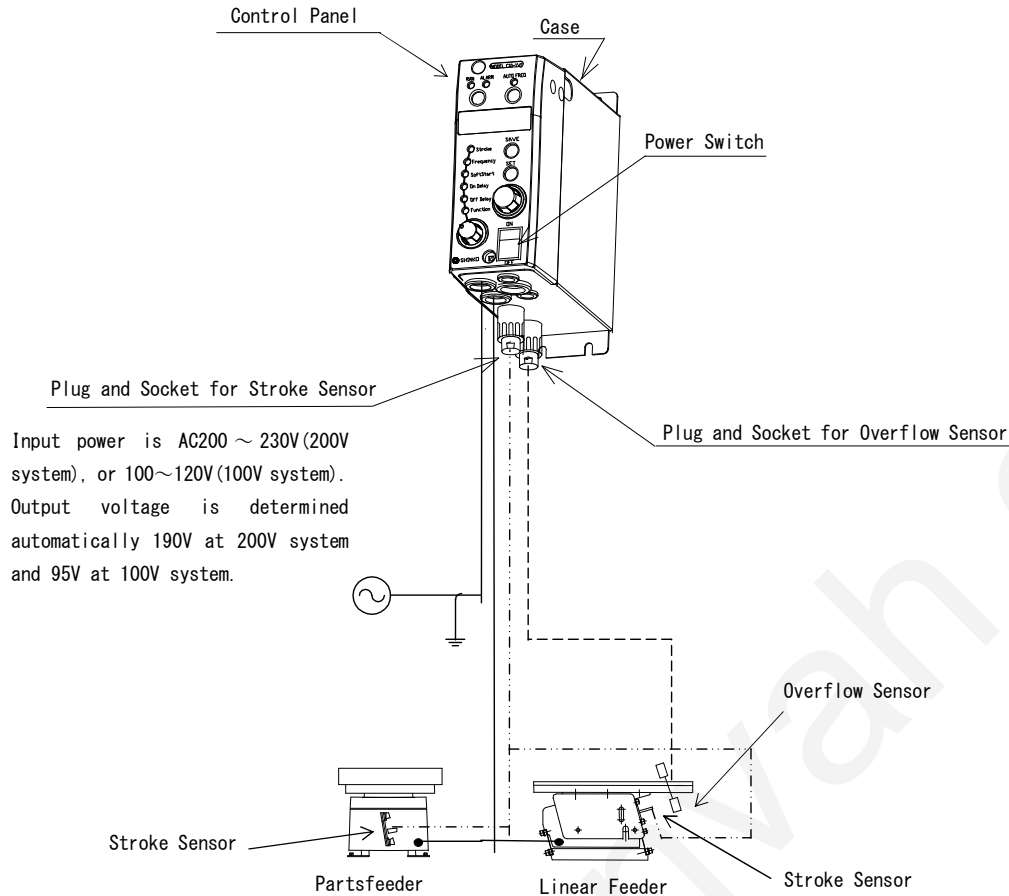

Input power is AC200 ~ 230V (200V system), or 100~120V (100V system). Output voltage is determined automatically 190V at 200V system and 95V at 100V system.

Note: See page 25 to 28 to use the Stroke sensor and Overflow sensor.

① Remove the control panel

Danger:
Before remove the control panel, disconnect and lock out the power supply at the safety disconnect switch.

② Connect power supply cable and the output cable for load. Connect the stroke sensor. Wire each cable or lead on the terminals through rubber bushings respectively. Power supply cable to terminals "IN1", "IN2" and "E". Output cable to terminals "OUT1", "OUT2" and "E".

Warning:
Connect the ground line to terminal "E" without fail

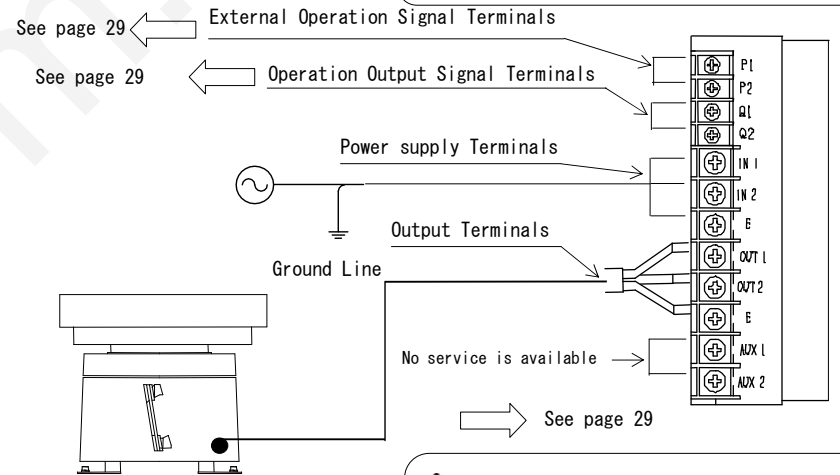

③ Close the control panel

Danger:
The control panel must be closed and secured while C10-controller is in operation. Or else the operator should get an electric shock.

Note: If any noise from the controller disturbs any other device, the controller should provide suitable noise suppression parts on it at your own expense. Please consult "Conformity with CE Marking" on page 36 for selection and installation of the parts.

How to operate the Control Panel

● : Turning on ◐ : Blinking ○ : Turning off

Name and Function of the Buttons, Lamps and Dials on the Control Panel

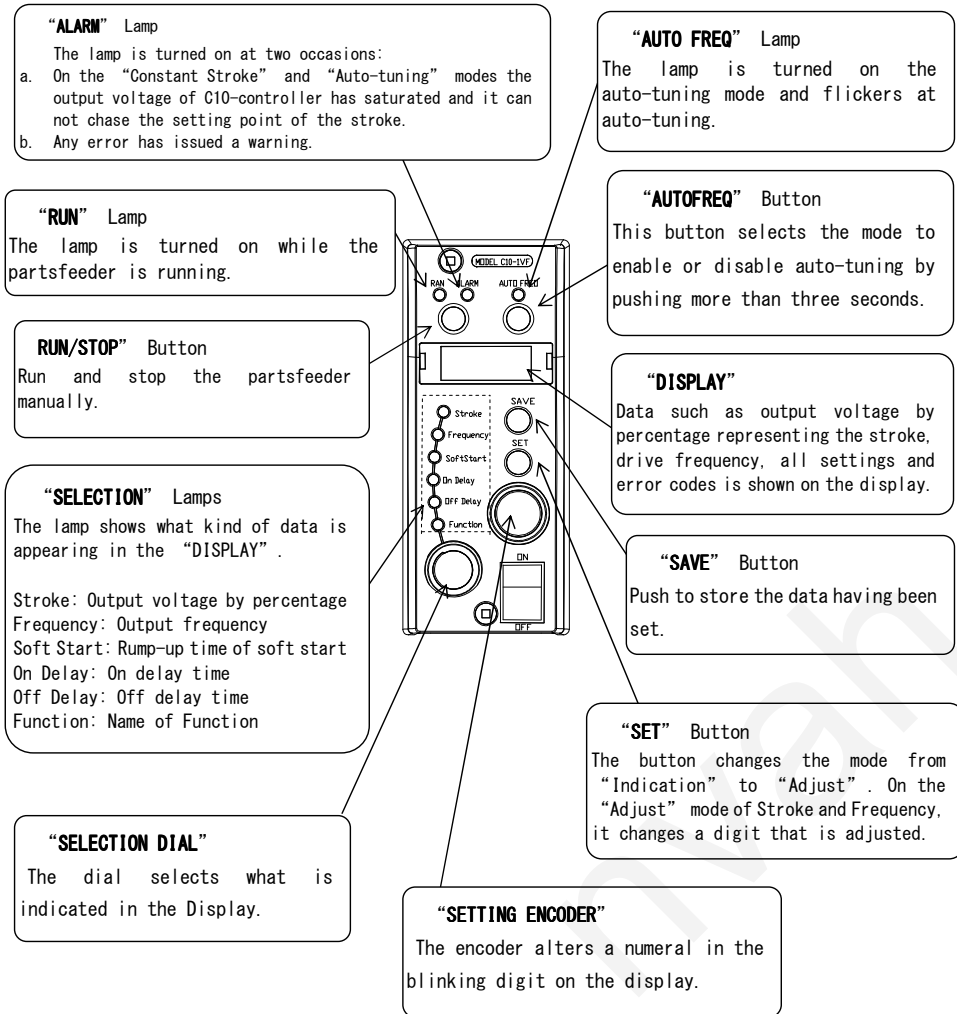

How to Run and Stop the Partsfeeder

1. Turn the power switch on.

Then directly the controller is running.

Note: If the function code “rS” for Run/Stop by the panel is set to “0” the controller is operated by “RUN/STOP” button.

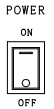

2. “RUN/STOP” button, when it is pushed, runs and stops the partsfeeder in turn.

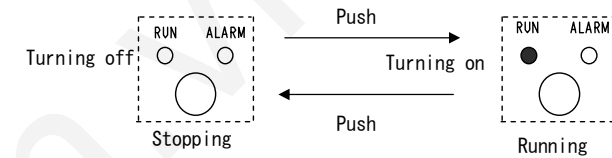

If RUN lamp is not turned on or the partsfeeder does not run even if the RUN lamp is turned on please check the following items.

When the Run lamp is blinking see the next articles.

- Estimated cause: The output voltage has been set for “0” .
Remedy: Set the output voltage.
- Estimated cause: The output drive frequency of C10-controller is off the resonance frequency of the partsfeeder.
Remedy: Adjust it near to the resonance frequency up to get enough stroke.
- Estimated cause: C10-controller stops by “Error” .
Remedy: Resolve the error indicated by “ERROR CODE” . See page 40.

Alarm by blinking “RUN” lamp

When “RUN” lamp blinks the external operation signal on the terminal “P1” and “P2” or Overflow sensor is set for stop even if “Run/Stop by Panel” is set for running.

RUN/STOP Button	External operation signal “P1” and “P2”	Overflow sensor	“RUN” lamp	Operation
Setting for running	Set for running		● Turning on	Running
	Set for stopping		◐ Blinking	Stopping
Setting for stopping	Unrelated		○ Turning off	

Basic Setting up Procedure

Basic setting up procedure is described here illustrating setting up of the Stroke. The same procedure is applied for setting up of Frequency, Soft Start Ramp-up time, On-delay and Off-delay time.

1. Select "Stroke" with the Selection Dial turning on "Stroke" lamp. Dialing the selection dial turns on selected lamp in the Selection Lamp and the set value of the selected function appears on the display.

Note: "Stroke" represents percentage of the output voltage or amplitude per the maximum.

Note: The first letter "U" of the data appeared on the display shows "setting by output voltage" and "A" shows "setting by amplitude".

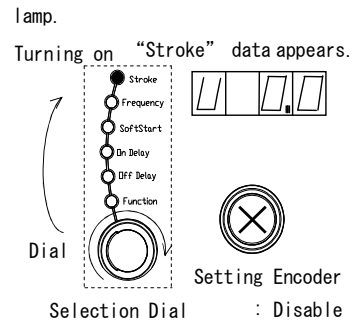

2. Push "Set" button to change the mode from "Indication" To "Adjust". It enables alteration of the data appeared on the display and the lowest digit blinks for alteration.

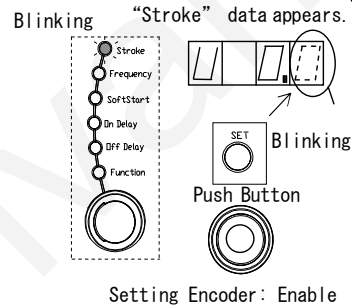

3. Dial the setting encoder up to appear a desirable setting value on the display. The digit blinking is changeable with the dial.

Note: On setting "Stroke" and "Frequency" push the Setting button to shift the digit blinking.

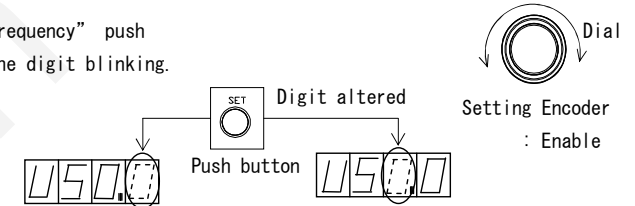

The "Setting of Stroke" must be set within the maximum stroke of the drive unit.

4. Push "Save" button to store the data having been set. After stored the data the selection lamp stops blinking and is turned on continuously. The alteration of the setting becomes effective by the procedure 3. However without "Save" action, turning the power switch off or dialing the setting dial to set another data cancels the procedure 3. and the data stored is not renewed.

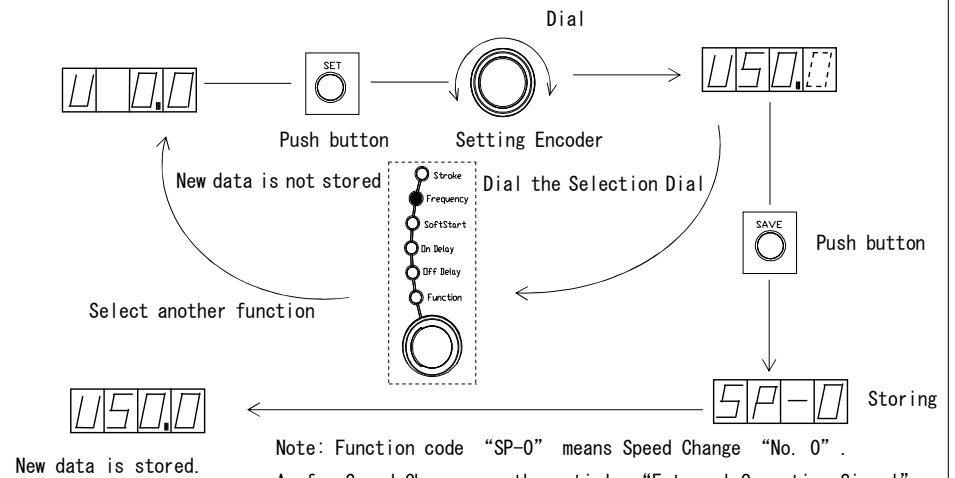

How to operate the Control Panel

-Continued-

How to adjust the Function Set Value

1. Dial the selection dial and select the function turning on "Function" lamp.

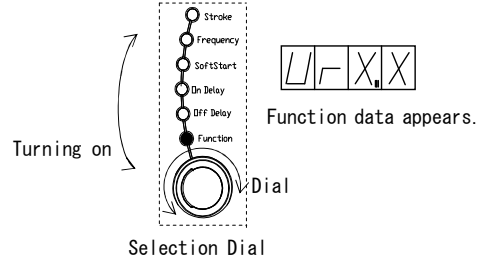

2. Dial setting encoder and select the function code altered.

Note: See page 39 for Function Codes and Functions.

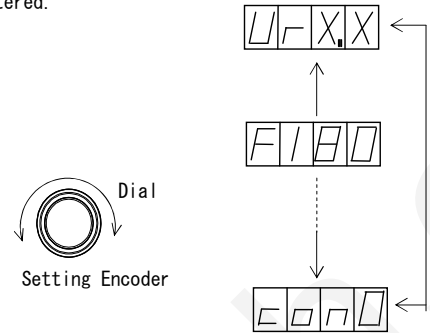

3. Push "Set" button to change the mode from "Indication" to "Adjust".
It enables alteration of the data appeared on the display and the lowest digit blinks for alteration.

Note: On the Error Code and Version Information, "Adjust" mode can not be selected.

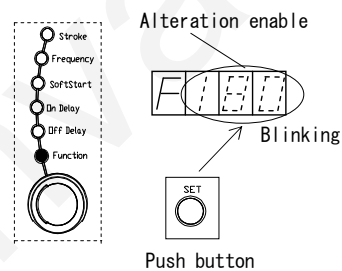

4. Dial the setting encoder up to appear a desirable setting value on the display.

The digit blinking is changeable by the dial.
The digit blinking is alterable with the encoder.
Please set a proper value on it.

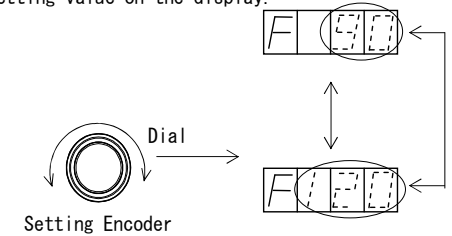

5. Push "Save" button to store the data having been set.

After stored the data the selection lamp stops blinking and is turned on continuously.

The alteration of the setting becomes effective by the procedure 4.

However without "Save" action, turning the power switch off or dialing the setting dial to set another data cancels the procedure 4. and the data stored is not renewed.

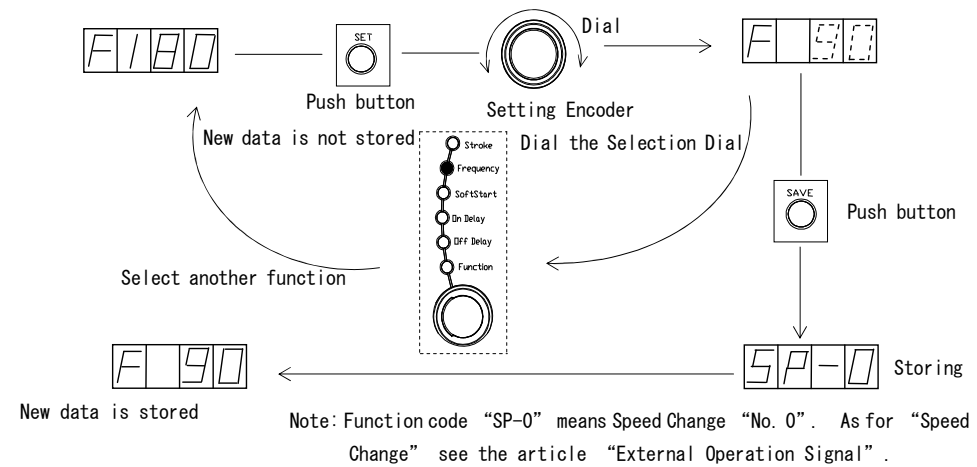

Initial Setting

Preparation for operation

The preparation for operation is described here. Please follow each setting and see the detail on the page in the hollow arrow

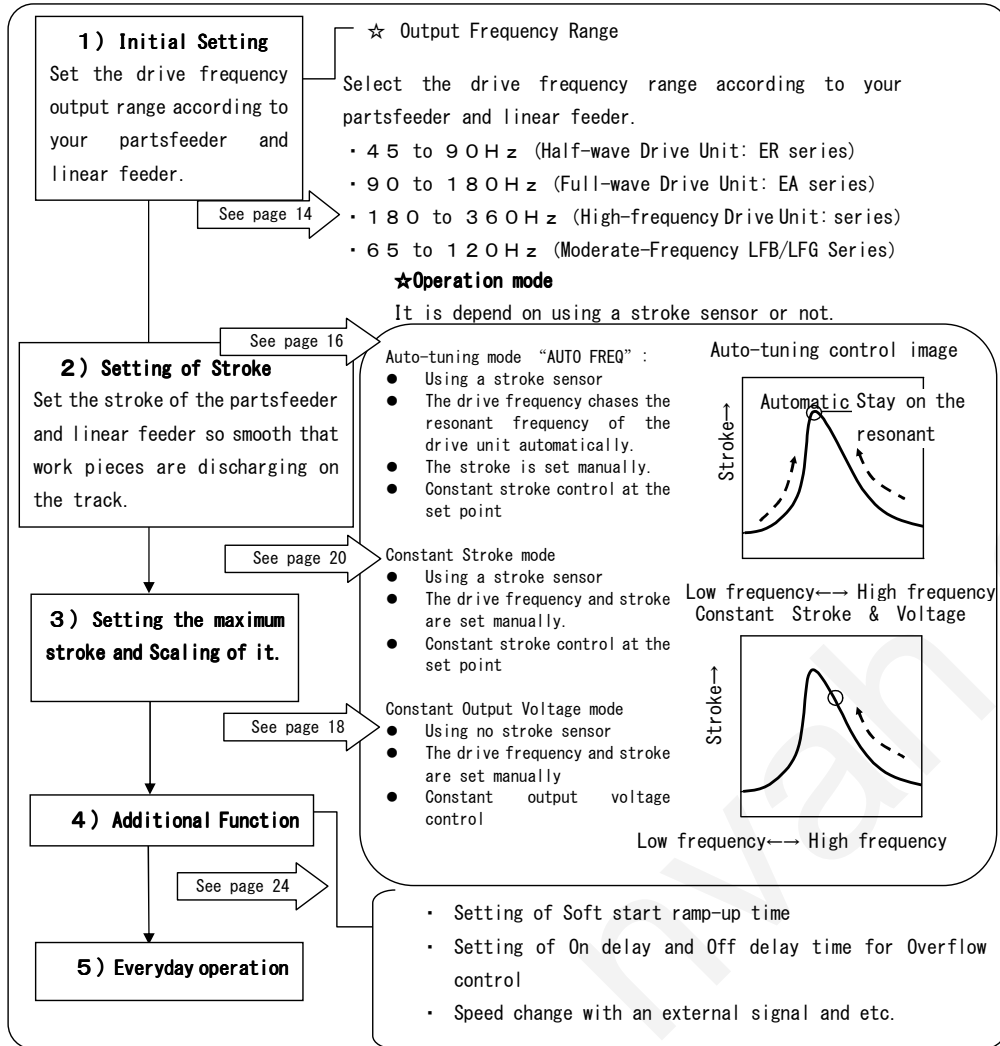

Any trouble arises during the adjustment please initialize the setting and restart the adjustment from the beginning.

See page 41

How to adjust the Drive Frequency Output Range

1. Dial the selection dial and select the "Function" turning "Function" lamp on.

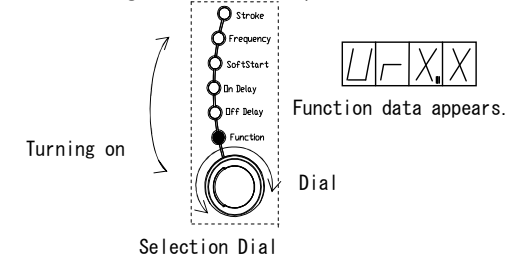

2. Dial the setting encoder up to appear code "F", Output Frequency Range, on the display.

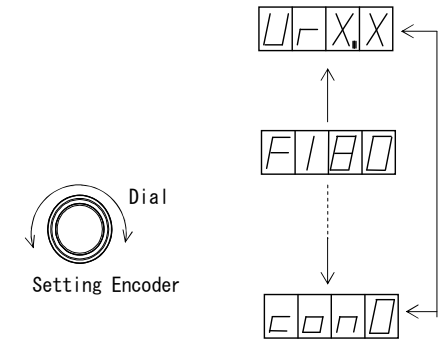

3. Push "Set" button to change the mode from "Indication" to "Adjust".

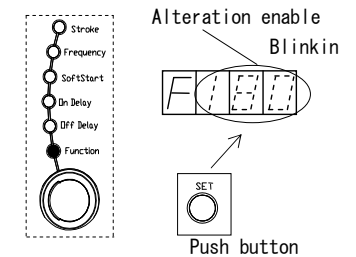

4. Dial the setting encoder and select the drive frequency for the partsfeeder/linear feeder controlled. The value of the function code shows the upper limit of the output drive frequency.

	Output Frequency Range	Type of Drive Unit
F 90	45 to 90Hz	Half-wave Drive Unit ER series
F 180	90 to 180Hz	Full-wave Drive Unit EA series
F 360	180 to 360Hz	High-Frequency Drive Unit series
F 120	65 to 120Hz	Middle-Frequency LFB/LFG Series

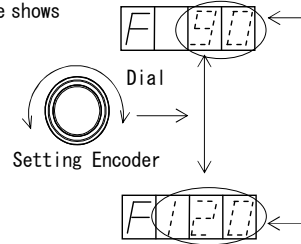

5. Push "Save" button to store the data having been set

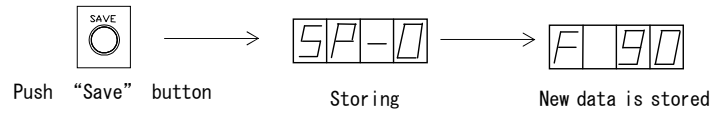

How to adjust the Stroke on the auto-tuning mode

After finished the setting of "Frequency Range", please set the stroke of the partsfeeder or linear feeder. Put some work pieces in the bowl or chute and set the stroke so that they are discharged smoothly on the track. In the case of "Model CF" drive unit the stroke must be set at the maximum of the unit. Please make sure:

- Stroke sensor is connected.
- "Auto Freq", indicating auto-tuning mode, lamp is turned on.

1. Dial the selection dial and select "Frequency" turning "Frequency" lamp on. The maximum output frequency selected in the initial setting appears on the display. Check the former selection is correct or not.

Frequency Range	Value
45~90Hz	90.0
90~180Hz	180.0
180~360Hz	360.0
65~120Hz	120.0

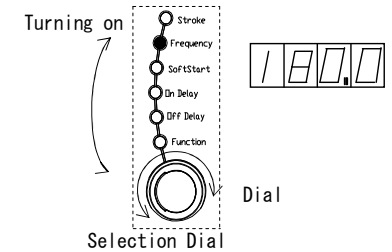

2. Push "RUN/STOP" button.

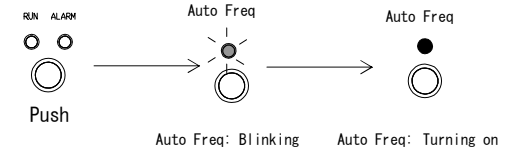

Then the partsfeeder is running and the output drive frequency chases the resonant frequency of the drive unit. The drive frequency becomes close to the resonant frequency the auto-tuning is completed. "Auto Freq" lamp is blinking during the tuning and turning on after it is completed.

How to set the stroke on the Constant Voltage Mode

3. Dial "Selection Dial" and select "Stroke" turning "Stroke" lamp on.

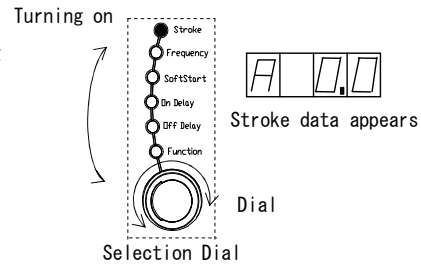

4. Push "Set" button to change the mode from "Indication" to "Adjustment".

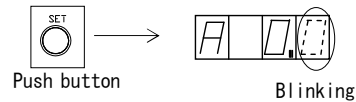

5. Dial setting encoder and set the stroke so that work pieces are discharged smoothly on the track. Push "Set" button to shift the blinking digit from decimals to units. In the case of "Model CF" drive unit the stroke must be set at the maximum of the unit and scaling must be done. See page 22. The "Setting of the stroke" must be set within the maximum of the drive unit.

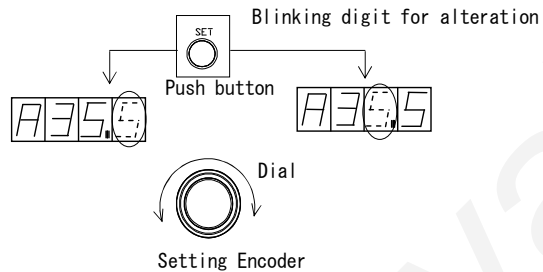

Note: When the set value is lower than 10.0 alter the sensor feed back gain "Fb" to "Fine" or "1". It spreads adjustable range of the stroke six times and it makes setting easy and precise.

6. Push "Save" button to store the data having been set.



After setting the "Frequency Range", set the stroke following the procedure below. Put some work pieces in the bowl or chute and set the stroke so that they are discharged smoothly on the track. Without the stroke sensor or pulling the plug connector of the stroke sensor off C10-controller, the running mode is "Constant Voltage" mode.

1. Dial "Selection Dial" and select "Stroke" turning "Stroke" lamp on.

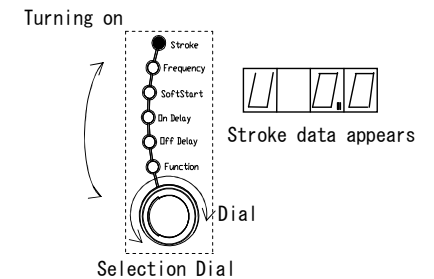

2. Push "Set" button and change the mode "Indication" to "Adjustment".

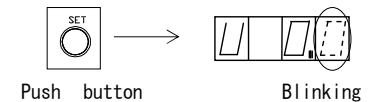

3. Dial "Setting Encoder" and set the value around 70 to 80 percent. Push "SET" button to shift the blinking digit from decimals to units. In the case of "Model CF" drive unit the value must be set at 90 percent.

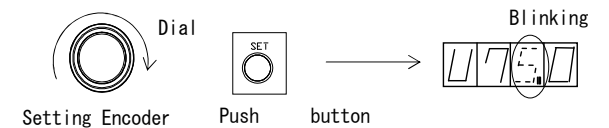

4. Push "Save" button to store the data having been set.

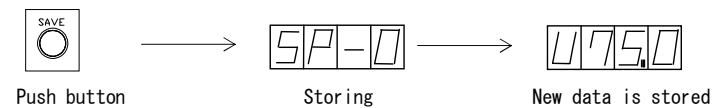

Initial Setting

-Continued-

5. Dial "Selection Dial" and select "Frequency".

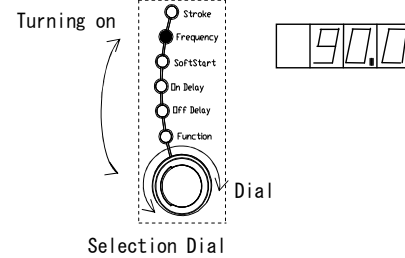

6. Push "Run/Stop" button and run the partsfeeder or linear feeder.

This example shows the partsfeeder is running at the output voltage 75 % and drive frequency 90 Hz.

Note: When RUN lamp is blinking see "Alarm by blinking RUN lamp" on the page 8.

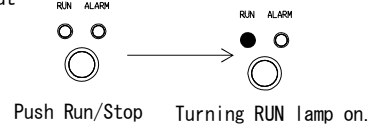

7. Push "Set" button to shift the mode from "Indication" to "Adjust".

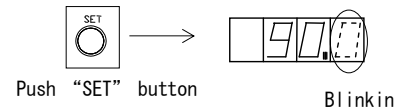

8. Dial the Setting Encoder in the counterclockwise to reduce the drive frequency so that the work pieces are discharged smoothly. Push "Set" button two times to shift the blinking digit from decimals to units.

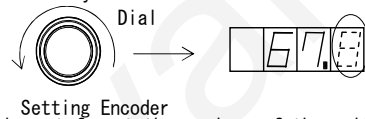

Note: In the case of "Model CF" drive unit the stroke must be set for at the maximum of the unit.

9. When the work pieces are discharged smoothly, push the "Save" button to store the data having been set.



How to set the Stroke on the Constant Stroke mode

After setting the "Frequency Range", set the stroke following the procedure below. Put some work pieces in the bowl or chute and set the stroke so that they are discharged smoothly on the track.

1. On the beginning, "Stroke" is set on the "Auto-tuning" mode. See "How to set the stroke on the auto-tuning mode".

2. Push "Auto Freq" button more than three seconds and change the mode from auto-tuning to constant stroke.

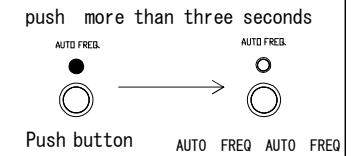

3. Dial "Selection Dial" to select "Function".

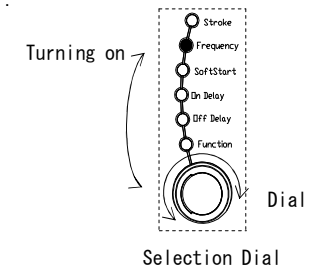

4. Push "Set" button to change the mode from "Indication" to "Adjustment".

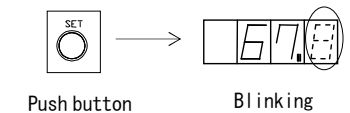

Scaling of the stroke

5. Dial the "Setting Encoder" to set the output frequency so that "ALARM" lamp is not turned on. The output frequency is generally adjustable manually within 3% against the auto-tuned.

When the stroke is hunting on the constant stroke mode reduce the gain on the Function code "G".

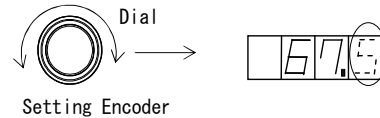

6. Push "Save" button to save the data having been set.

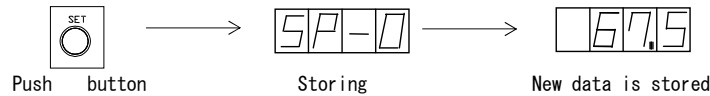

Scaling of the stroke converts usable stroke range into controllable range as 0 to 100%. The usable stroke range is from the minimum to the maximum stroke set in the former procedure. Before scaling the stroke, the value means a percentage per the output voltage of controller but after scaling, the value means a percentage per the controllable range. A CF drive unit, control by 4-20mA current and control by two-rate-of-feed must require the scaling. The scaling must be done on the setting of combination No. 0, Speed change signal, and function cord "rnt 0", Control by Panel.
 Note: No scaling is done on the other setting such as combination No. 1, 2 and 3 and/or function cord "rnt 1" and "rnt 2".

1. Adjust and set the "Stroke" on the usable maximum stroke of the bowl or chute.

Note: The stroke must be set within the maximum stroke of the drive unit.



maximum stroke data

2. Dial the selection dial and select the function turning on "Function" lamp.

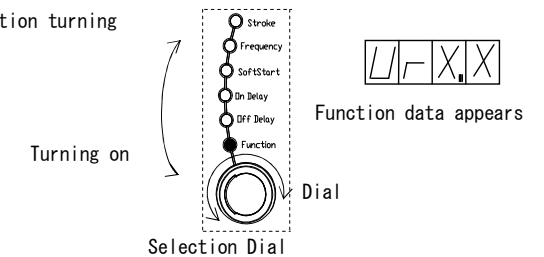

3. Dial the setting encoder up to appear function cord "H" for a scaling coefficient.

The scaling coefficient appears on the display.

The scaling coefficient means a proportionality constant that converts a stroke data into the controllable range.

Example: Original stroke data "30.0" percent per the output voltage

Alter the scaling coefficient 1.00 to 2.00 and then

Stroke data converted "60.0" percent per the controllable range

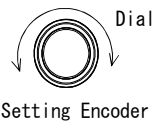

4. Push "Set" button to change the mode from "Indication" to "Adjust".

The second decimal place of the scaling coefficient blinks.

Another push enables to change the first decimal place.

Note: Dial the setting encoder to set a new coefficient or to reset old one to the original "1.00".

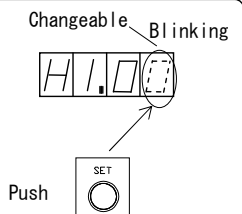

5. Push and hold the “Set” button more than three seconds and the minimum scaling coefficient that converts the present stroke data into just “100” appears on the display. coefficient is calculated automatically in the machine.

Example: Present stroke data “30.0” percent per the output voltage
 After it converted “100” percent per the controllable range
 The coefficient calculated $100/30.0=3.34$
 The third decimal place is rounded up.

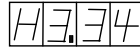

Push and hold more than 3 seconds

6. Push “Save” button to store the data having been set.



Push



Storing



Converted

7. Dial the selection dial and select the “Stroke”.

Make sure that “100” appears on the display.

In the case that the stroke has been set on every combination No. 1, 2 and 3 all settings are converted with the scaling coefficient calculated above.

There is no need to reset them again.

Turning on

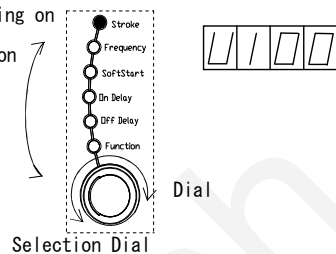

Dial

Selection Dial

Additional Function

Setting up for Keylock function

On the ‘Keylock’ function code, the window shows ‘Loc0’ as the default. Then select ‘Loc1’ to make keylock effective and push ‘SAVE’ button to fix the setting. Under the keylock condition, push ‘SET’ button and then the window shows ‘Loc’ . Under the ‘Loc’ condition, the preset data are fixed and the controller never be initialized. If you want to change the preset data, release the keylock with setting up ‘Loc0’ .

Setting of On Delay and Off Delay Time

When work pieces discharged are full on all the length of the chute the partsfeeder must stop automatically, that is called “Overflow” function.

To set the overflow function follow the procedure below.

Note: See the next article as for the connection diagram of the overflow sensors.

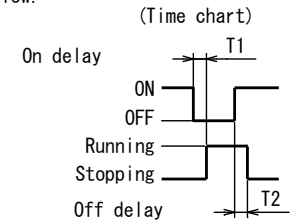

Select “On Delay” of “Off Delay” with the Setting Dial and set the delay time.

Adjustable time is 0.2 to 60 seconds.

The default is set for 0.2 seconds.

- a. “On delay”

On delay time is a duration the partsfeeder restarts after the overflow sensor signals “OFF” or close contacts refrained from “ON” or open contacts. Recommended duration “T1” is 0.2 to 0.5 seconds generally.

- b. “Off delay”

Off delay time is a duration the partsfeeder stops after the overflow sensor signals “ON” or open contacts sensing work pieces on the track. Recommended duration “T2” is 1.0 to 1.2 seconds generally.

Setting of Soft Start Ramp-up Time

Ramp up time of a partsfeeder or linear feeder depends on many factors such as the drive frequency, weight of a bowl or chute, air gap of core and armature, and so on.

If necessary, dial the selection dial to select “Soft Start” and adjust the ramp up time between 0.2 to 4.0 seconds that is adjustable.

The default is set for 0.5 seconds.

Note: On the auto-tuning mode or constant stroke mode, the soft start ramp up time follows not always the preset value depending on the characteristic of the drive unit.

To improve it, adjust the “Control Gain G” .

Larger gain makes partsfeeder restart early and smaller gain makes it restart slower.

Additional Function

-Continued-

Connection of Overflow and Stroke sensors

Connection of Overflow Connector "Work Sensor"

a. C10-controller provides power supply, DC 12V and maximum 80 mA, to the Overflow sensor with a plug and socket connector, three cored, on it.

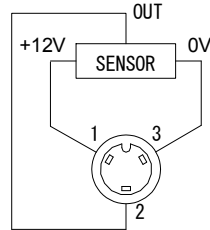

b. Dry contacts or Open Collector, maximum sink current 10 mA, is connected to the No.2 and No.3 core of the plug connector controls C10-controller. When No.2 and No.3 core is closed the partsfeeder stops. When No.2 and No.3 core is open the partsfeeder runs.
No.2 and No.3 core is open: On Delay setting
No.2 and No.3 core is closed: Off Delay setting

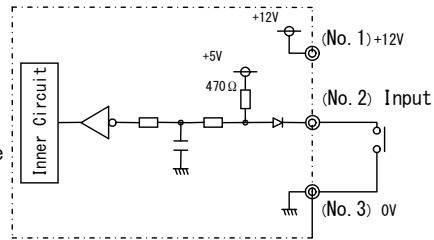

Dry contacts or Open Collector
Open : Run
Close : Stop

Note: A proximity switch powered by DC with two cores can not be used.

Connection of Stroke sensor "PF/LF Sensor"

Connection diagram is shown on the right side.

Note: The maximum wiring cable length should be 10m. When the cable is longer than 10m a shield cable with an excellent high-frequency characteristic must be used.

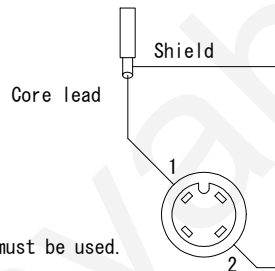

Caution: On the soldering of the cable on the cores of a plug connector, do not mistake the shield for the core nor the core for the shield.

Mounting of a stroke sensor on a partsfeeder

- The stroke sensor must be mounted on in front of a leaf spring with a sensor support. See the list of the support on the table below that is classified with the model of the drive unit.
- The sensor support is screwed together with the leaf springs with the leaf spring fixing bolt on the base frame side or bottom without model EA-15 and EA-20. The supports of model EA-15 and EA-20 must be screwed on the armature or top. In this case function code "SEn X" must be set for "X=1". See page 28. The bolt should be longer than usual by the thickness of the support.
- The sensor must be off the leaf spring by 0.5mm and it is called the "air gap".
- Fix the cable with some slack on it to prevent secondary-excited vibration or contact with any obstacle to break it.
- Recommended stroke sensor is: Model EH-110 Proximity sensor by Keyense

the base frame side

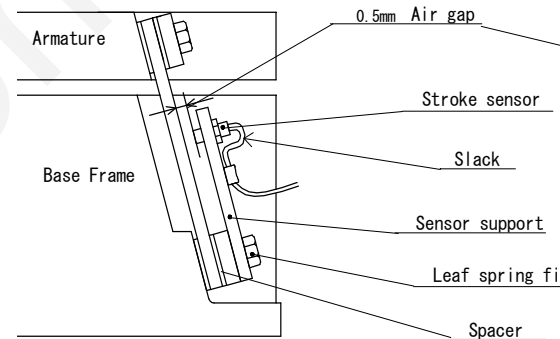

the armature side

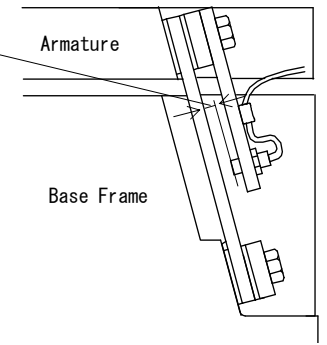

Size of Sensor support

Drive Unit	W	φ D	L 1	L 2	Fixing Direction
EA-15, EA-20 (Previous model)	19	8.5	75	55	Armature
EA-15B	16	7	45	25	Base Frame
EA-20B	19	9	50	30	Base Frame
EA-25, ER-25	19	10.5	80	55	Base Frame
EA-30, ER-30	25	12.5	80	55	Base Frame
EA-38, ER-38	32	16.5	80	55	Base Frame
EA-45, ER-45	32	16.5	80	55	Base Frame
ER-55, 65, 75	32	16.5	90	60	Base Frame

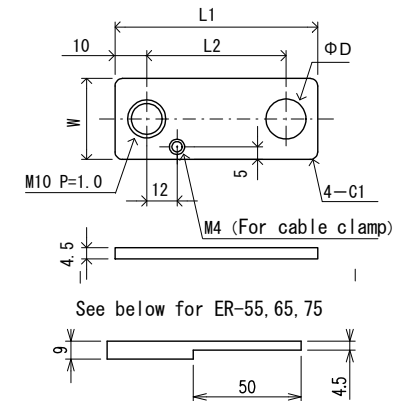

Mounting of Stroke sensor on a linear feeder

- Model LFB and DFG series are using leaf springs made of Glass-fiber reinforced plastic and the proximity sensor does not detect them. The stainless bar as an object sensed must be mounted on in front of a leaf spring. The stainless bar is screwed together with the leaf springs with the leaf spring fixing bolt on the bowl side or top.
- The stroke sensor must be mounted on in front of the stainless bar. The sensor support is screwed together with the leaf springs with the leaf spring fixing bolt on the base frame side or bottom. The sensor must be off the bar by 1.0mm and it is called the "air gap". The width of the gap changes by the vibration of the drive unit and the change is detected with the proximity sensor. The bolt must be longer than usual by the thickness of the support and the bar.
- Recommended stroke sensor is "EH-305 Proximity sensor" by Keyence.

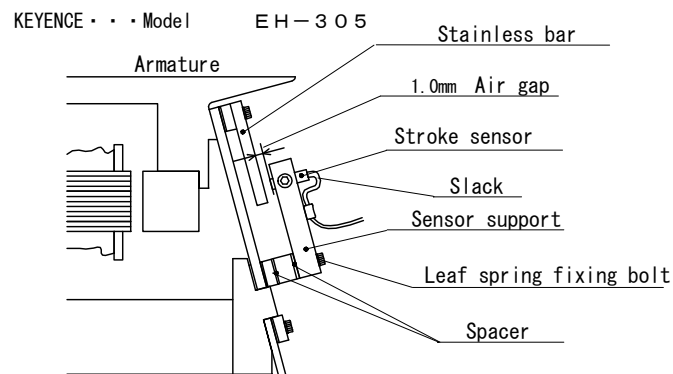

d. Size of the stainless bar / Top and bottom

The table shows model of a linear feeder and the size of the stainless bar.

Drive Unit	Mounted position	ϕD	L 1	L 2	H 1	H 2
LFB-300	Top	4.5	35	25	15	4
	Bottom	4.5	35	25	8	4
LFB-400	Top	5.5	40	28	20	5
	Bottom	5.5	40	28	10	5
LFB-550	Top	6.5	45	31	25	6
	Bottom	6.5	45	31	12	6
LFG-750	Top	8.5	55	37	30	8
	Bottom	8.5	55	37	16	8

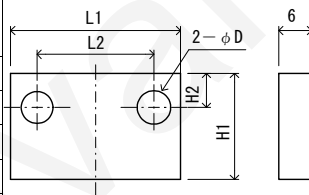

Size of the stainless bar / Top and bottom

The table shows model of a linear feeder and the size of the stainless bar.

Drive Unit	ϕD	L 1	L 2
LFB-300	4.5	35	12
LFB-400	5.5	40	17
LFG-600			
LFB-550	6.5	45	22
LFG-750			
LFG-900	8.5	50	27

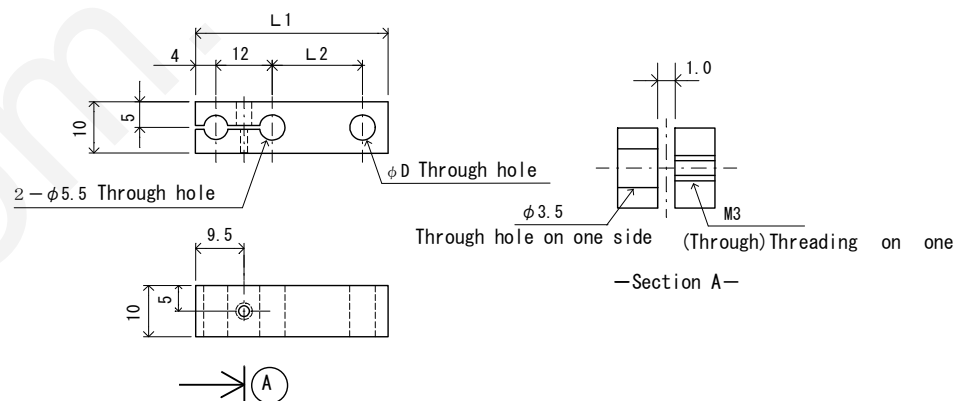

Function setting suits for an arrangement of the Stroke Sensor.

It is not necessary to set the Function Code **SEEX** according to the phase of the air gap on the program version 6 or later.

The phase of the air gap is automatically detected when the auto-tuning of initial setting is completed.

Manual setting is available by setting the Function Code.

Sen0: The phase is reverse. "Reverse" means when the magnet on the drive unit pulls down the armature the air gap becomes wide.

Sen1: The phase is synchronous. "Synchronous" means when the magnet on the drive unit pulls down the armature the air gap becomes narrow.

Sen2: Automatically set

How to use External Signal Terminals

Please wire the external signal terminals as the drawing in the columns below for frequent running and stopping, taking out synchronous signal with running and stopping and speed change of a partsfeeder.

External Operation Signal Terminals P1 and P2

☆Running and stopping with an external signal

Close or open the terminals P1 and P2 respectively with an external relay with dry contacts or an open collector.

Select control by 4-20mA current or Two-rate-of-feed with a slide switch on the print circuit board.

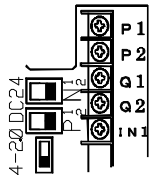

Logic is reversible by Function code " \overline{EONX} ". "X" is set for "0" or "1".

Logic of the external contacts open or close

X	0	1
Open	Run	Stop
close	Stop	Run

○ Dry contacts or an open collector

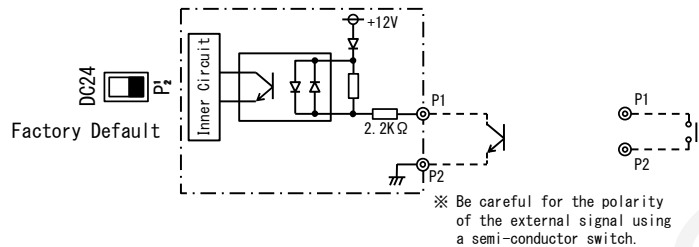

○ External voltage

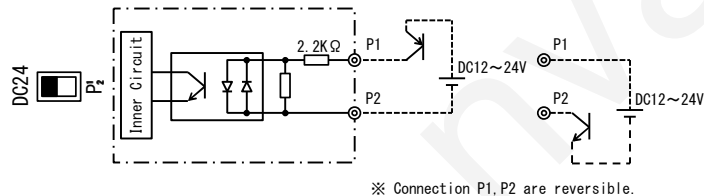

Operation Synchronous Signal Terminals Q1 and Q2, and AUX. OUT

Operation Synchronous Signal Terminals Q1 and Q2

The terminal Q1 and Q2 outputs the synchronous signal with running and stopping of the partsfeeder.

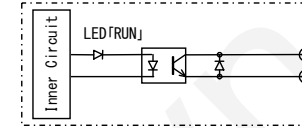

The output transistor closes when a partsfeeder is running.
Maximum output voltage: DC 24 V
Maximum output current: 80 mA

Operation Synchronous power output terminals AUX. OUT

The terminals, AUX1 and AUX2, output power supply synchronous with operation of the partsfeeder.

Output voltage: The same as the input voltage to

C10-controller

Maximum current: 2A

AUX OUT (2A)

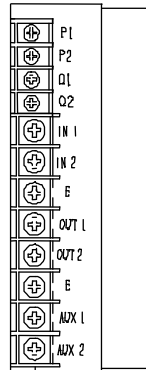

Speed change/Control by 4-20 mA current/Two-rate-of-feed control by external Rheostats

Warning! : Before remove the control panel, disconnect and lock out the power supply at the safety disconnect switch.

Caution! : Fault connection of "E-Con1" and "E-Con2" should damage C10-controller. There is no indication of "E-Con1" or "E-Con2" on the printed circuit board.

Location of the Connectors

Remove the panel and a side cover.

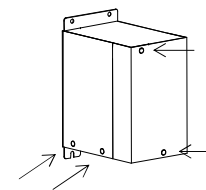

E-Con2

The connector must be connected to one of two connectors named "4321" on the printed circuit board.

The left side socket connector "E-Con2" is used for control by 4-20 mA current or two-rate-of-feed by two external rheostats.

The connector must be connected to one of two connectors named "E-Con" on the printed circuit board.

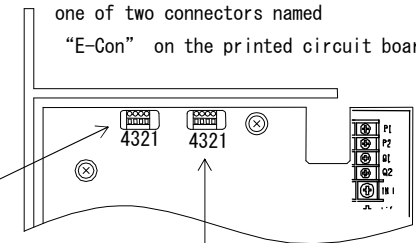

E-Con1

The right side socket connector "E-Con1" is used for speed change and error signal output.

To use those functions an output or input cable must be connected with a special plug connector model "XN2A-1430 by OMRON that is provided by customer.

Connection Diagram

E-Con1

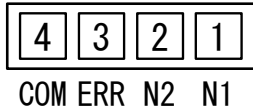

Select control by 4-20mA current or Two-rate-of-feed with a slide switch on the print circuit board.

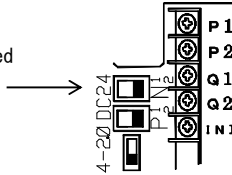

○ Dry contacts or an open collector

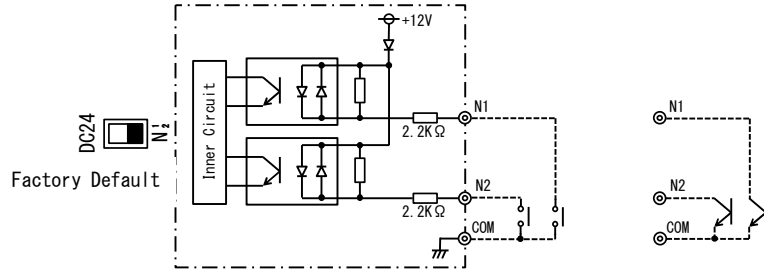

○ External voltage

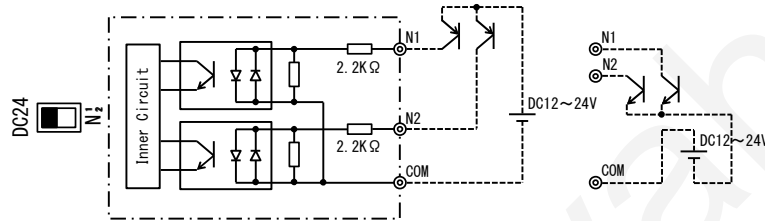

Output of error signal

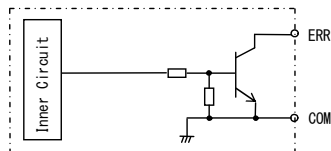

Maximum output voltage: DC24 V
Maximum output current: 80mA

Output transistor closes by error such as "E-OL" and so on.

4-20mA Current control / Two-rate-of-feed

Please select control by 4-20mA current or two external rheostats with a slide on the print circuit board.

The default is set for control by two external rheostats.

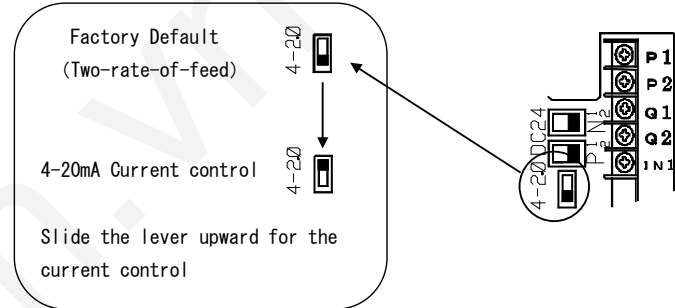

E-Con2

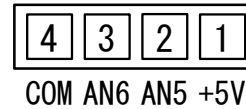

○ Two-rate-of-feed

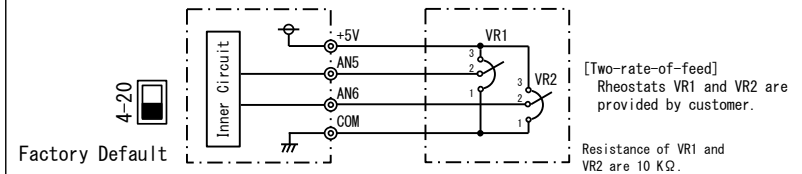

○ 4-20mA Current control

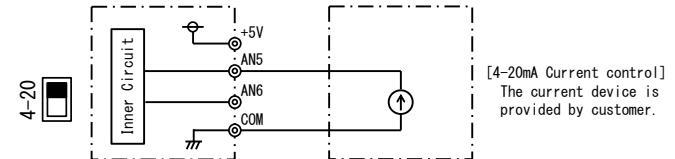

Caution!: Fault connection of "E-Con1" and "E-Con2" should damage C10-controller. There is not indication of "E-Con1" or "E-Con2" on the printed circuit board.

Speed Change Signal

Combinations of “Open” or “Close” between terminals “COM” and “N1”, and “COM” and “N2”, with contacts provided by customer, determines “Combination No.” See table below.

Combination of “Combination No.” and Function “Remote” determines behavior of C10-controller. See table below.

Note: Two external rheostats or a current control must have been wired before the function cord “rnt X” will be set for “X=2” or “X=1”.

Combination No.	0	1	2	3
N1 and COM	Open	Close	Open	Close
N2 and COM	Open	Open	Close	Close

Combination No. / Function code	0	1	2	3	Remarks
	Panel	Panel	Panel	Panel	Running by the stored data
	4-20mA	Panel	Panel	Panel	The Combination No.0 determines running by 4 - 20 mA current control.
	VR1	VR2	Panel	Panel	The combination No.1 and 2 determine running by the external rheostats. See note below.

Note: “Panel” in the table means running by stored data, the stroke and the driving frequency.

Note: On the maximum setting of the external rheostat the stroke data appears on the display is not “100” but “over 95”.

How to store the Speed Change Signal

Please follow the procedure below to set the Combination No.1 to No.3.

The procedure must start on the Combination No. 0 or open the terminals “Com” and “N1”, and “Com” and “N2”.

1. Set and save the stroke on the Combination No.0.
2. Running the partsfeeder, input the external signal “N1” and “N2” according to the Combination No.

After the action the Combination No. appears on the display as “SP-X” for “X=1 or 2 or 3” for two seconds.

The drive frequency is that is set on the Combination No.0.

Caution: If the input signal “N1” and “N2” are changed while the partsfeeder is stopping the drive frequency stored is cleared and replaced with the maximum.

3. Dial the setting dial and select “Stroke” and set the stroke required with the setting encoder.
4. Push “Save” button to store the data. After that the Combination No. stored appears on the display for two seconds as “SP-X” for “X=1, 2, 3”.

Note 1: After stored the stroke the partsfeeder runs by it even if the external signal “N1” and “N2” are changed.

Data of stroke, drive frequency, soft start ramp-up time and on delay and off delay times are stored for each Combination No.

Note 2: When the drive frequency is reset on Combination No.1 to 3, the partsfeeder must be stopped and then change the external signals “N1” and “N2”.

How to wire the "E-Con" connector

Applicable wire gauge: AWG28/0.08 sq. mm to AWG20/0.5 sq. mm.

The external diameter must be less than 1.5mm.

Procedure

1. Remove the covering, 7-8 mm long, according to the "Strip Gauge" on the connector.
Twist the twisted wire some turns.

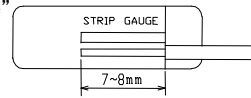

2. Push a white clamp lever into the plug connector with a minus driver up to lock the lever.

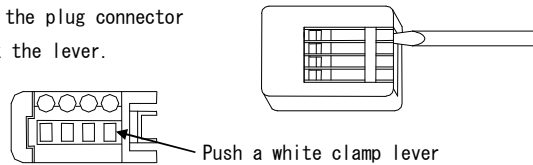

3. Insert a conductor of a cable deep into the connector as a covering of the cable is entering the connector and the conductor has reached clamp port.

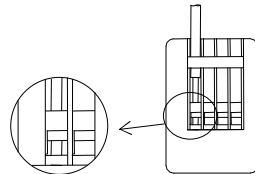

4. Insert a minus driver into the release port and pull the lever back. The lever clamps the conductor with "clap" sound.

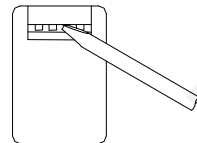

5. Confirm the levers are released and clamp each conductor. Pull the cable and the connector lightly with your hands and you feel light resistance the cable is connected securely.

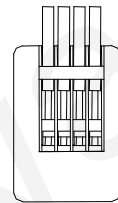

Disconnection of the cable

1. To release the cable push the white clamp lever into the connector up to lock it. Then pull off the cable.
2. Be sure to release the clamp lever after disconnection of the cable. However, the other cable is going to be connected do the work as the lever is locked.

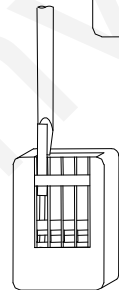

CE Marking requires conditions mentioned below and installation of noise filters. Under the conditions the controller conforms to the EC Directive.

Directives conforming to:

Low Voltage Directive (200/95/EC) EN50178 : 1988

EMC Directive (2004/108/EC) EN61000-6-2 : 2005

EN61000-6-4 : 2007

1. Installation

- a. The controller should be installed in an enclosure appropriate for IP4X.
- b. The clearance between the controller and the four walls of the enclosure should be wider than 100 mm.
- c. Where more than two sets of the controller are installed in an enclosure the controllers keep clearance of 10 mm off mutually.
- d. The atmospheric temperature in the enclosure has to be kept lower than 40 degree Celsius or a cooling fan must be provided for.

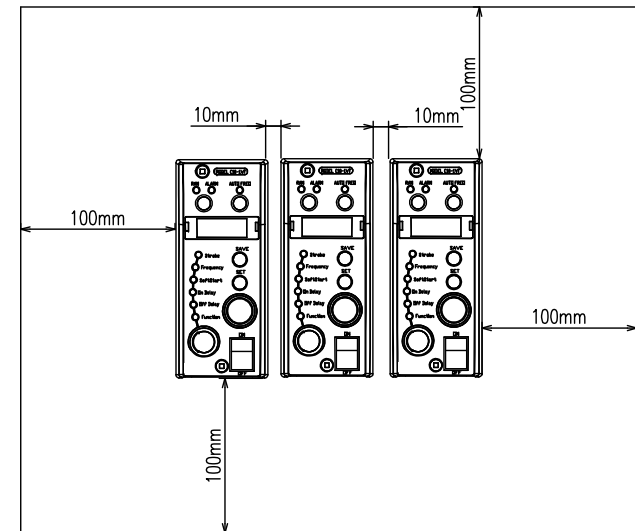

2. Noise filter

- The input and output power line of the controller should install noise filters mentioned below on them.
- Addition to them, a single phase noise filter should be installed on the input power line prior to the clamp filter.

Clamp filter

ZCAT3035-1330 made by TDK

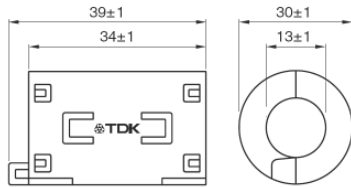

Single phase noise filter

RSHN2006 made by TDK-Lambda

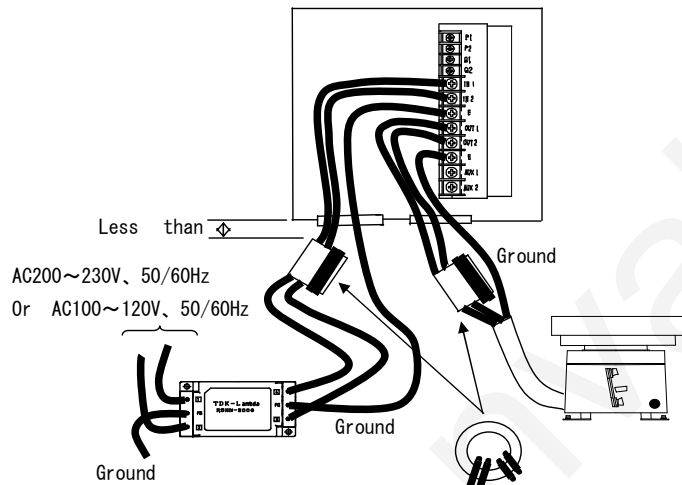
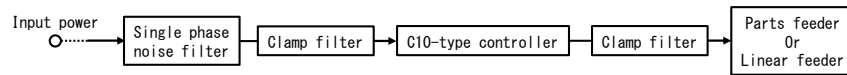
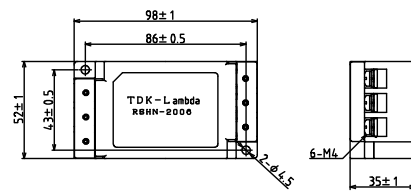

Please wind each power lines on the clamp filters once.
 You may wind the ground line together with the power lines.
 Those lines must be passing through the orifice of the clamp filter twice.
 Winding the ground line together with the power line results no performance-sapping.

In the case of two or three sets of controller are installed in the same enclosure and the power supply for them may be connected in a row, only one single phase noise filter and one clamp filter should be installed on the original input power line.

Exception: C10-5VF or C10-5VFEF must not be connected in a row, they must require a single phase filter and a clamp filter for each set.

Three sets of the C10-type controller at the most are connectable in a row power supply without the above exception.

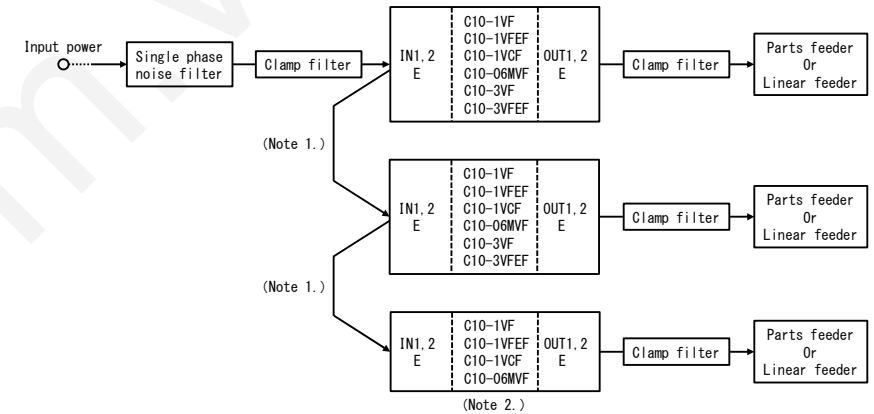

Note 1.







The power supply passing through a single phase filter and a clamp filter should be connected to the controllers in a row. The power cable connecting two sets of the controller must be shorter than 150mm.

Note 2.

In the case of three sets of the controller are connected in a row, one of the three sets must be C10-1VF, C10-1VFEF, C10-1VGF or C10-06MVF.











Trouble Shooting

First Checking Item	Remedy
● Does the resonant frequency of the partsfeeder match the driving frequency range of C10-controller?	● Review the function setting. ● Readjust the resonant frequency of the drive unit with leaf springs
● Is the setting of the drive frequency range correct?	● Review the function setting.
● Is the weight of a bowl or chute too heavy for the drive unit?	● Reduce the weight with a decrease of thickness of a bowl or chute. ● Adjust the air gap.
● Is there any fault wiring, confusing polarities, the stroke sensor and C10-controller?	● Review the wiring plug connector. ● Narrow the air gap of the core and armature of the drive unit.
● Is the air gap out of the standard width?	

Trouble	Checking Item	● Turning on	○ Blinking	○ Turning off	
A. Feeder does not run	 <ol style="list-style-type: none"> 1. Fault wiring of power source 2. Low voltage, supply rated voltage 3. Fuse FU1melts down 				➔ See page 6
B. Feeder does not run	 <ol style="list-style-type: none"> 1. Stop by the external operation signal 2. Overflow signal is working. 				➔ See page 29 ➔ See page 25
C. Feeder does not run	 <ol style="list-style-type: none"> 1. Fault wiring to the feeder/Cable breaks 2. Fault setting of Stroke 				➔ See page 5 ➔ See page 9
D. Feeder does not run	 <ol style="list-style-type: none"> 1. The stroke sensor is not working, removed or broken lead. 2. Stop by over current protection <p style="margin-left: 20px;">2-1. Fault wiring to the feeder/Any short circuit 2-2. Drive frequency range is out of the resonant frequency of the drive unit 2-3. The air gap of the drive unit is too wide</p>				➔ See page 26 ➔ See Manual of the feeder
E. Stroke does not build up	 <ol style="list-style-type: none"> 1. Fault setting of Stroke on the panel 2. Too wide air gap of the drive unit 3. Fault function setting for the Stroke Sensor 4. Feeder provides a bowl out of the specification 				➔ See page 9 ➔ See Manual of the feeder
F. Stroke fluctuates	 <ol style="list-style-type: none"> 1. Fault wiring the shield cable and plug connector 2. Loose fitting of the bowl 				➔ See page 25 ➔ See Manual of the feeder
G. Memory stores no setting	 <ol style="list-style-type: none"> 1. You did not store the data before off the power 				➔ See page 9

Function Table

Function Table

Function Code	Name of Function	Applicable Range	Factory Default	Remarks
Ur 	Information on version	Program Version	Ex. 1.0	See page 11
F 	Drive frequency range	90:45 to 90Hz (Half-wave) 180:90 to 180Hz (Full-wave) 360:180 to 360Hz (High-frequency) 120:65 to 120Hz (Middle-frequency)	180	See page 14
Sen 	Direction of stroke sensor	0: Reverse phase 1: Synchronous phase 2: Automatic setting	0	See page 28
rnt 	Remote	0: Panel operation 1: 4-20 mA current control 2: Two-Rate-of-Feed with two external rheostats	0	See page 30
E- 	Error code	Error Code of arising error	E-	See page 41
rS 	Run/Stop by the Panel mode	0: Running and stopping by RUN/STOP button on the panel 1: Power supply runs the feeder ignoring RUN/STOP button	1	See page 8
con 	Logic of external signal "P1", "P2"	0: "P1" and "P2" is open 1: "P1" and "P2" is close	0	See page 29
H 	Scaling of the stroke	Scaling coefficient: 1.00 to 5.00	1.00	See page 22
G 	Control Gain	Gain Range: 0.01 to 9.00 On the auto-tuning and constant stroke mode, adjusting gain improves responsibility and stability of soft start and etc.	1.00	See page 21 See page 24
Fb 	Feedback Gain	0: Normal 1: Fine In the case frequency range "F360" is selected the feedback gain is set for "Fine" automatically.	0/1	See page 17
Loc 	Key Lock	0: Lock off 1: Lock on	0	See page 24

Accessory List

Name of Part	Model		Manufacture
	On C10-controller	On the Load	
Plug connector (2P)	CN-70-AJ-2P	CN-70-P-2P	SATO PARTS
Plug connector (3P)	CN-70-AJ-3P	CN-70-P-3P	SATO PARTS
Fuse (F1)	C10-5VFEF:EWM 250V 5A C10-3VFEF:EWM 250V 5A C10-1VFEF:EWM 250V 3.15A	_____	FUJI TERMINAL INDUSTRY CO., LTD.
Fuse (F2)	EWM 250V 2A (Synchronous power output)	_____	FUJI TERMINAL INDUSTRY CO., LTD.

Specifications

Model		C10-1VFEF	C10-3VFEF	C10-5VFEF
Power Source		AC200~230V±10% AC100~120V±10% 50/60Hz		
Control Type		PWM		
Output	Voltage	0~190V (Input power 200V system) 0~95V (Input power 100V system) When power source is AC 100V system the output voltage is 0 to 190V with an optional transformer unit C10-TR.		
	Frequency	Half-wave : 45~90Hz Full-wave : 90~180Hz High-frequency : 180~360Hz Middle-frequency : 65~120Hz		
	The maximum current	1A	3A	5A
Operation mode	Auto-tuning mode	The output drive frequency chases the resonant frequency of the drive unit automatically and C10-controller controls the stroke constant.		
	Constant stroke mode	C10-controller controls the stroke constant at the preset drive frequency.		
	Constant voltage mode	C10-controller outputs the constant voltage at the preset frequency		
Additional function	Speed change	An external signal selects any stroke setting out of four preset values.		
	Run/Stop operation	An external signal runs or stops the partsfeeder.		
	Output signal	C10-controller outputs a synchronous signal with running and stopping of the partsfeeder.		
	Soft start	Ramp-up time 0.2 to 4 seconds		
	On and Off delay	Delay time 0.2 to 60 seconds		
	Power source for sensors	With a 3 cored socket plug		
Synchronous power output	Function	Power output synchronous with the partsfeeder operation		
	Control method	Run/Stop with a triac		
	Output voltage	Same as Power Source		
	Maximum current	2A		
Applicable condition	Ambient temperature	0~40°C		
	Ambient moisture	10~90% (No condensation is allowed.)		
	Workable location	Indoor without corrosive gas and dust or harmful circumstance		
	Noise resistance	1000V or more		
	Color of case	U75-70D (JAPAN PAINT MANUFACTURERS ASSOCIATION)		
	Outline dimensions	59W×170H×150D (without mass of plug connectors)		119W×170H×150D (without mass of plug connectors)
Applicable model	Mass	0.9Kg	1.0Kg	1.6Kg
	Partsfeeder	EA series : EA-15. 20 ER series : ER-25	EA series : EA-25. 30. 38. 45 ER series : ER-30. 38. 45	ER series : ER-55. 65. 75
	Linear feeder	LFB series : LFB-300. 400. 550 LFG series : LFG-600. 750. 900		
	CF feeder	CF series:CF-1, 2, 3	CF series:CF-4	